



Chevy Metro

# BASE PLATE

## BOLT TORQUE SPECIFICATIONS

| STANDARD BOLTS: |       |            | METRIC BOLTS: |            |
|-----------------|-------|------------|---------------|------------|
| Size            | Grade | Torque     | Size          | Torque     |
| 5/16"           | 5     | 20 ft/lbs. | 8mm           | 22 ft/lbs. |
| 3/8"            | 5     | 35 ft/lbs. | 10mm          | 42 ft/lbs. |
| 7/16"           | 5     | 56 ft/lbs. | 12mm          | 70 ft/lbs. |
| 1/2"            | 5     | 85 ft/lbs. | 14mm          | 95 ft/lbs. |

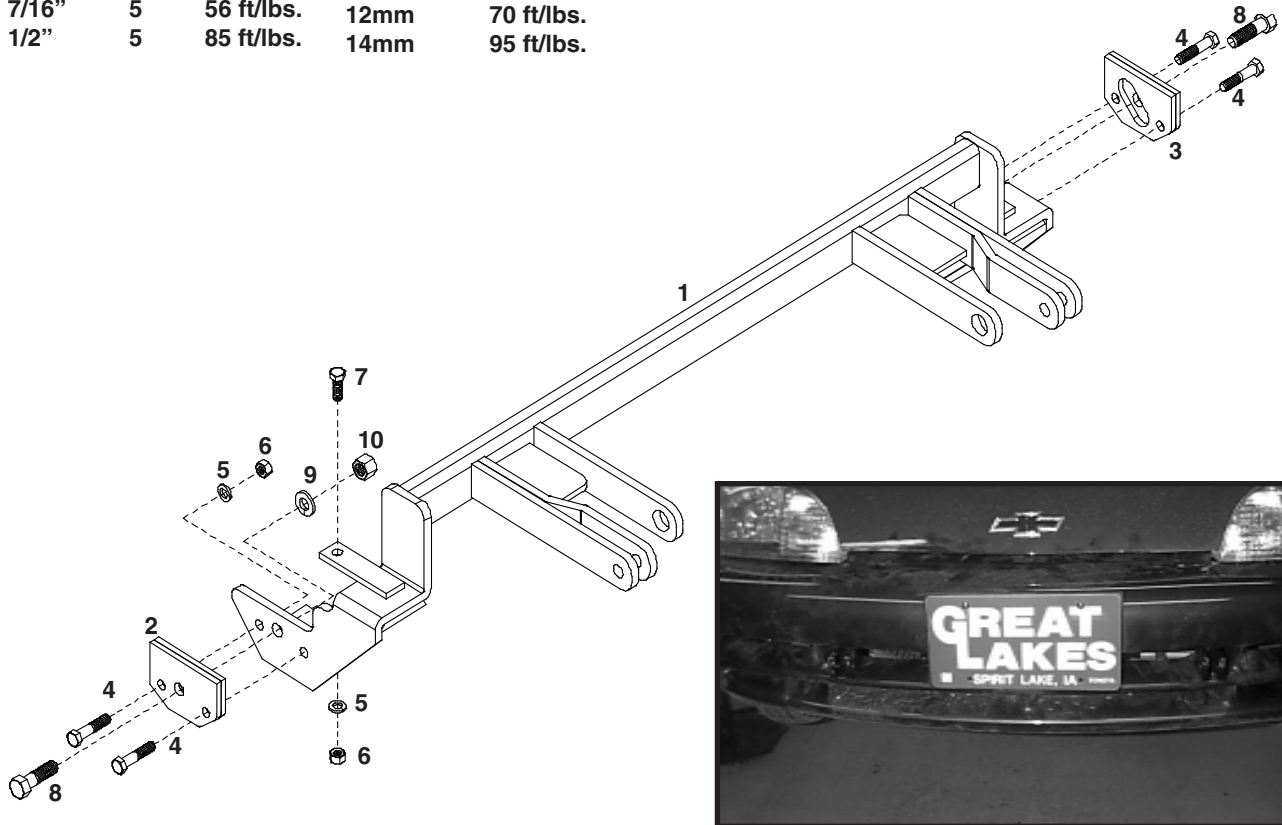

### (9517064) PARTS LIST

| REF. NO. | PART NO. | QTY. | DESCRIPTION                        |
|----------|----------|------|------------------------------------|
| 1.       | 09416-35 | 1    | Mounting Bracket                   |
| 2.       | 09238-35 | 1    | Right End Support Clamp            |
| 3.       | 09239-35 | 1    | Left End Support Clamp             |
| 4.       | 00908    | 4    | 3/8"-16 UNC x 1-3/4" Hex Head Bolt |
| 5.       | 00060    | 6    | 3/8" Lockwasher                    |
| 6.       | 00907    | 2    | 3/8"-16 UNC x 1" Hex Head Bolt     |
| 7.       | 00061    | 6    | 3/8"-16 UNC Hex Nut                |
| 8.       | 00482    | 2    | 1/2"-13 UNC x 1-3/4" Hex Head Bolt |
| 9.       | 00084    | 2    | 1/2" Lockwasher                    |
| 10.      | 00083    | 2    | 1/2"-13 UNC Hex Hut                |
| 11.      | 12329    | 1    | Loctite(not shown)                 |

Please order replacement parts by PART NO. and DESCRIPTION.

ASSEMBLY  
OPERATION  
REPLACEMENT PARTS

**READ** complete manual CAREFULLY  
BEFORE attempting operation.

Doing Our Best to Provide You the Best

**WARNING: FAILURE TO FOLLOW THESE INSTRUCTIONS CAN RESULT IN LOSS OF TOWING VEHICLE CONTROL, SEPARATION OF THE TOW BAR FROM THE TOWING VEHICLE, SEPARATION OF THE TOWED VEHICLE FROM THE TOW BAR, CAUSING SEVERE PERSONAL INJURY, DEATH, OR PROPERTY DAMAGE.**

## CAUTION

Safety is of utmost importance at all times. There are several items that must be checked each time before using and while using a tow bar. Before allowing anyone to hook up or operate a tow bar, be sure they have read and understand the proper operating procedure.

**DO NOT** use worn or damaged cables and/or pins.

Be sure the **SAFETY CABLES** are hooked, chassis to chassis, to both the towing and towed vehicles using the crisscross method.

Check clearance between vehicles in a turning situation.

Check base plate mounting bolts for tightness and frame for metal fatigue.

Do not load the towed vehicle with anything as you may exceed the towing capacity of the tow bar.

Keep fingers away from pivot points to prevent personal injury.

Be sure the steering components of the towed vehicle are properly aligned.

**NOTE:** This unit can be backed up in moderate increments. Any severe backwards cornering could result in damage to the Tow Bar and/or towed vehicle chassis.

**For automatic transmissions:** Consult your vehicle owners manual for towing suitability with the drive shaft connected. Otherwise, the towed vehicle will have to be equipped with a transmission pump or drive shaft disconnect.

Check to make sure that all lights are in proper working order.

**The information on towability of vehicles is reprinted with permission of MotorHome® Magazine, and is believed to be reliable. However, Demco does not warrant the information to be correct. Always consult your towed vehicle owner's manual and follow towing instructions. Each year, MotorHome® Magazine, compiles a list of vehicles that can be towed four-down behind a motorhome with no modifications required. This guide contains only those vehicles that have been approved by their manufacturers for towing. This list is enclosed with this manual.**

 **Caution: MotorHome® Magazine** left out any vehicles that have towing speed limits slower than 55 m.p.h., or distance limits of less than 200 miles. At a minimum, these vehicles require significant modification, such as the use of an aftermarket product, to make them towable. The availability of a **Demco Tow Bar Base Plate** does not imply that these vehicles can be modified or that there is an aftermarket product available. Refer to your vehicle owner's manual or consult your dealer to determine whether your vehicle can be modified to make it towable. Failure to observe this precaution could result in property damage or personal injury.

**NOTE: The dimensional variations between otherwise identical vehicles can be considerable. Some minor modifications may have to be made to ensure a proper fit.**

## IMPORTANT INSTALLATION ITEMS

DEMCO products and accessories are intended to be installed by professional installers with experience, proper equipment and the ability to do modification work. Installers with these qualifications can be found in RV and Automotive Service Centers.

If the car to be towed has been in an accident, the chassis may be damaged in an area where the Base Plate attaches. It may no longer be suitable for towing. Extreme caution and careful examination are required in such a situation. It is also likely, even from a minor accident, that the hole alignment will be more difficult due to hole alignment problems.

Many DEMCO Base Plates are designed to use existing holes and hardware to mount the Base Plate to the towed vehicle. Even though the bolt is there, however, do not assume it is adequate for mounting the Base Plate. Manufacturers make many changes in hardware both within and between model years. Be sure the bolt is long enough to protrude past the nut a distance no less than 1/2 the diameter of the bolt, after the Base Plate is mounted. The threads should be in good condition. **We require that “*LOCTITE® Blue*” be used on all bolts.** If a new bolt is required, be sure it is SAE Grade 5 or Metric 8.8.

## INSTALLATION INSTRUCTIONS

1. Remove horizontal bolt that bolts the bumper to the car frame (located by looking inside thru grill opening). Do this on both sides.
2. Remove bottom three fasteners from bottom of fascia shown at right.



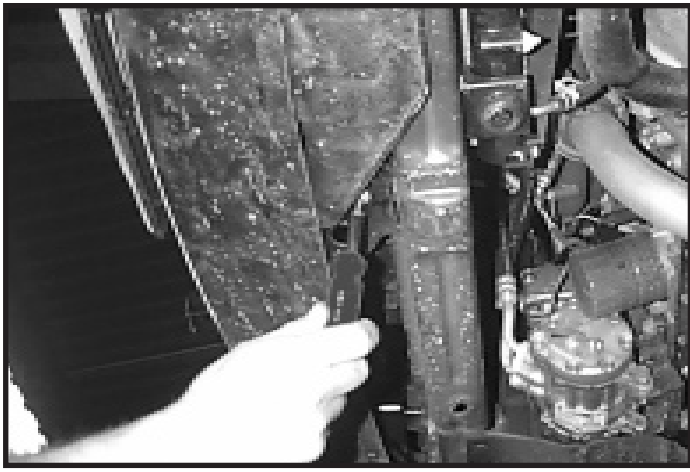

3. Remove screw located on the bottom center of bumper that attaches the bumper to the frame.

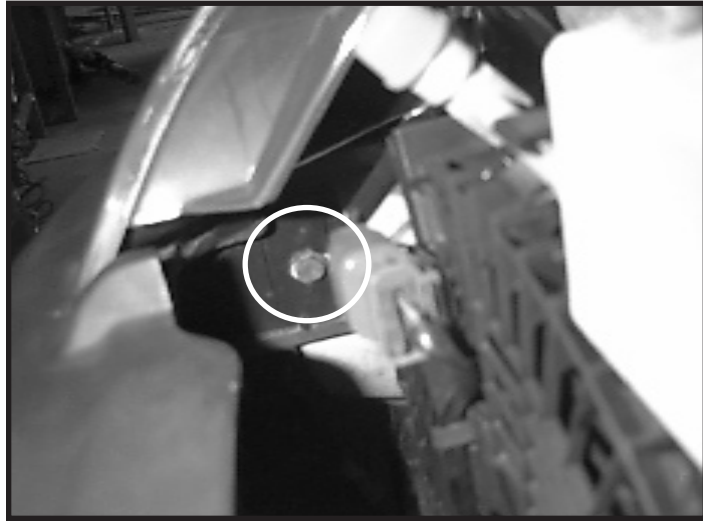

4. Open hood and loosen bolt which holds the bumper to the inside of frame. (circled at left) **Note: This bolt does not need to be removed.**



5. Remove the two screws that attach the bumper to the fender and the splash guard. Remove bumper and set aside.



6. With help from another hold baseplate into position. The outside end brackets should slide to the inside of the tie down brackets on the vehicle, and the flat tabs welded on the end brackets should slide on top of the vehicles frame crossmember. (Refer to 6b on next page)

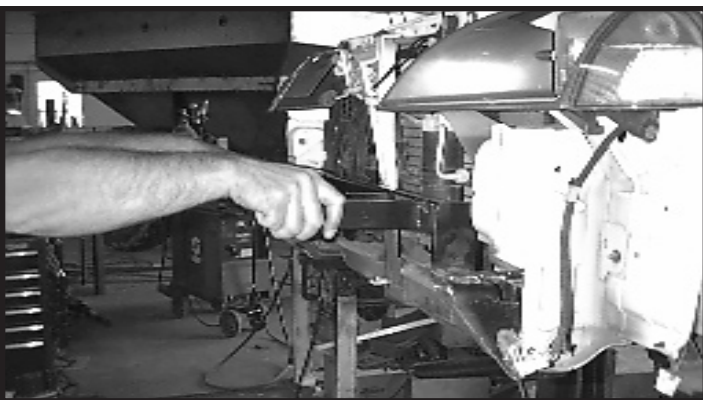



6b. (cont.)

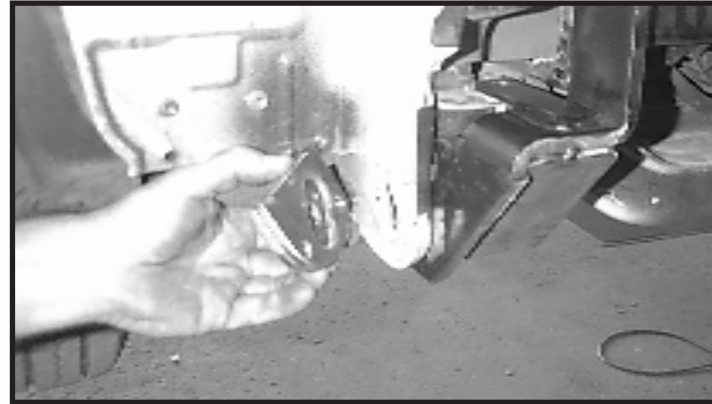

7. With the correct support plate start the 1/2" x 1-3/4" bolt through the center holes of the support plate, and the end bracket on baseplate, lightly tighten with 1/2" hex nut.

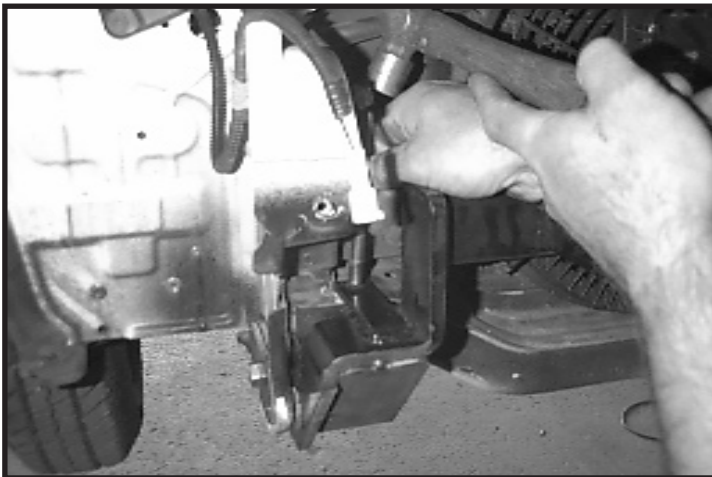
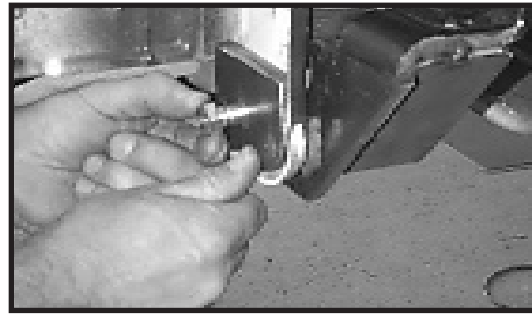

8. The holes in the flat mounting tabs should be centered on the frame crossmember, adjust baseplate to achieve this then tighten the 1/2" bolts.

Slide bumper back on and check for fit. Make adjustments if needed. When baseplate is centered, and bumper removed transfer punch holes to be drilled on the crossmember lip. **Note: Coolant tank should be loosened to transfer punch on drivers side.**

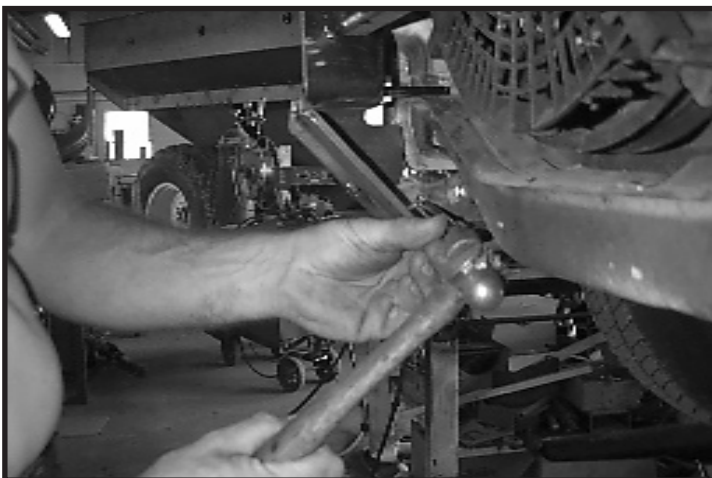

9. Transfer punch the front holes on the baseplate end bracket. This is done from the inside. Remove baseplate at this time.

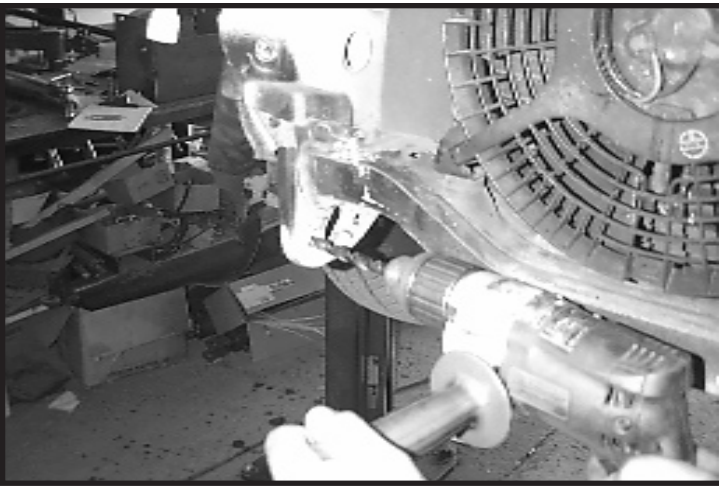

10. Drill 13/32" holes that were transfer punched into the tie down brackets.



10b. Drill 13/32" holes in crossmember lip. This hole should be drilled from the bottom up by measuring location of transfer punch mark on top and relocating to the bottom of lip, **Note: Be careful of coolant tank when drilling.**

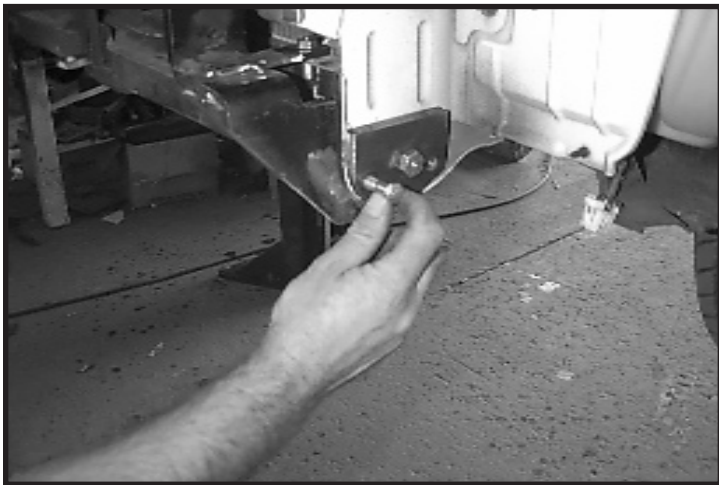

11. Reinstall baseplate with the 1/2" x 1-3/4" bolts. Use 3/8" x 1-3/4" bolts in the front two holes on baseplate and support plates. Use 3/8" x 1" bolts in the mounting tabs. Snug these bolts. Drill 13/32" hole from the outside of the tie down bracket, through the support plate, and through baseplate. Install 3/8" x 1-3/4" bolts. Do the same on other side.

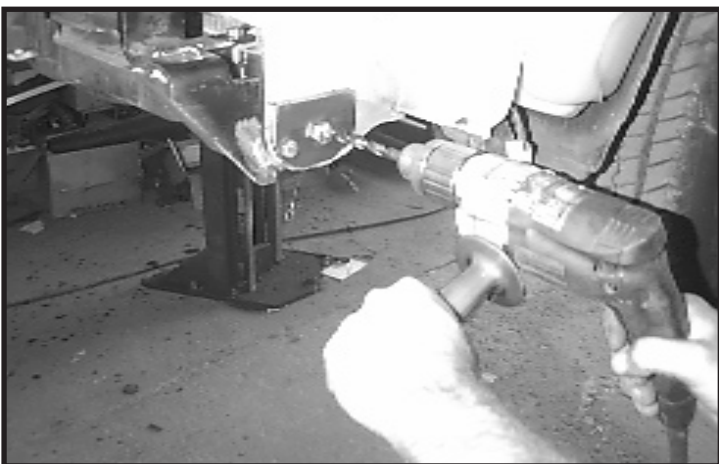

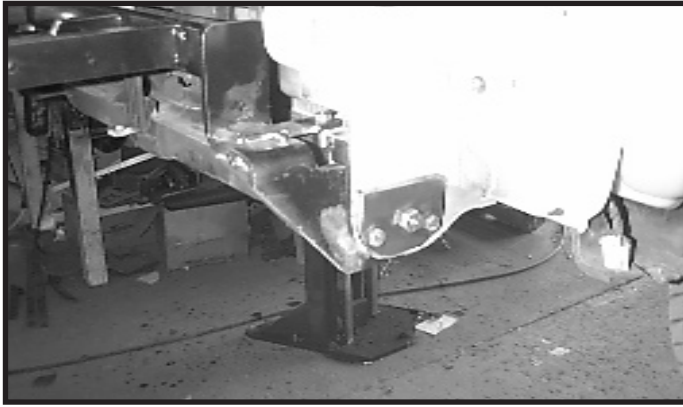

12. Tighten all bolts to specifications. Remember to use **LOCTITE**® blue on all bolts.



13. Measure 4" from grill upright on bumper assembly and mark. With the 4" mark in center cut a 3/4" wide by 1/2" deep relief slot for bracket. Do this on both sides.



14. Reinstall coolant tank, bumper assembly, and turning lights.



# Warranty Registration

4010 320th Street • Box 189 • Boyden, Iowa 51234  
Toll Free 800-54DEMCO (800-543-3626) • FAX 800-845-6420  
www.demco-products.com

|        |                       |
|--------|-----------------------|
| Ag     | <input type="radio"/> |
| RV     | <input type="radio"/> |
| Rental | <input type="radio"/> |
| Brakes | <input type="radio"/> |
| Marine | <input type="radio"/> |

|  | Very Satisfied        | Satisfied             | Dissatisfied          | Very Dissatisfied     |
|--|-----------------------|-----------------------|-----------------------|-----------------------|
| How satisfied are you with our product?  | <input type="radio"/> | <input type="radio"/> | <input type="radio"/> | <input type="radio"/> |
| How satisfied are you with the dealership/distributor sales staff?               | <input type="radio"/> | <input type="radio"/> | <input type="radio"/> | <input type="radio"/> |
| Dealer/Distributor Name _____ City _____ State _____                             |                       |                       |                       |                       |
| How satisfied are you with the company sales staff?                              | <input type="radio"/> | <input type="radio"/> | <input type="radio"/> | <input type="radio"/> |
| How satisfied are you with the delivery?   | <input type="radio"/> | <input type="radio"/> | <input type="radio"/> | <input type="radio"/> |
| Did you have any contact with a Demco Representative?                            | YES                   | NO                    |                       |                       |
| If <b>YES</b> , how satisfied were you?  | <input type="radio"/> | <input type="radio"/> | <input type="radio"/> | <input type="radio"/> |
| I would recommend this product to my family and friends.                         | YES                   | NO                    |                       |                       |
| Would you purchase again from DEMCO?   | YES                   | NO                    |                       |                       |
| Since taking delivery, have you been contacted by the dealer?                    | YES                   | NO                    |                       |                       |
| Did you have any problems with this DEMCO product?                               | YES                   | NO                    |                       |                       |
| If <b>YES</b> , are you satisfied with the company's resolution of your problem? | <input type="radio"/> | <input type="radio"/> | <input type="radio"/> | <input type="radio"/> |

Why did you purchase this product? \_\_\_\_\_

Please list the specific source of information prompting this purchase.  
\_\_\_\_\_

After purchasing this product, do you see any needed product improvement? \_\_\_\_\_ If yes, what improvement? \_\_\_\_\_

What other products would you like to see DEMCO offer? \_\_\_\_\_

Comments \_\_\_\_\_

**Owner's Name:** \_\_\_\_\_ **Mailing Address:** \_\_\_\_\_

**City:** \_\_\_\_\_ **State:** \_\_\_\_\_ **Zip Code:** \_\_\_\_\_

**Model#:** \_\_\_\_\_

**Serial #:** \_\_\_\_\_

**Purchase Date:** \_\_\_\_\_

**Owner's Signature:** \_\_\_\_\_

Please return to DEMCO By FAX or tri-folding this form to the backside, it is pre-addressed.

Postage

*Demco  
4010 320th Street, Box 189  
Boyden, Iowa 51234*

# DEMCO PRODUCTS ORIGINAL PURCHASERS LIMITED WARRANTY

## 1. Extent and Duration of this Warranty:

Your Demco product has a Lifetime Limited warranty to be free from defects in materials and workmanship under normal use and service from date of purchase by the original (first) retail owner, or until it is resold or transferred by the original owner. Any part of the Demco product found in the judgement of the manufacturer to be defective in materials or workmanship will be repaired or replaced at the manufacturer's option without charge for parts or labor to the original owner.

## 2. Manufacturer and Warrantor:

Demco  
4010 320th Street  
P.O. Box 189  
Boyden, IA 51234  
(712) 725-2311

## 3. Repair or Replacement Procedure:

If your Demco product develops a defect during the warranty period, promptly notify Demco customer service department. Until such notice is received, Warrantor will not be responsible for any repair or replacement.

Upon receipt of notice from you, Warrantor will have a choice of options in replacing any part it determines to be defective:

- a) Warrantor may require you at your own expense to deliver or ship the part to its factory or authorized dealer. Any defective part will be repaired or replaced and returned to you free of charge. Any part returned to Warrantor and found not to be defective will be returned to you freight collect with an explanation.
- b) Warrantor may elect to ship a new part to its dealer to be exchanged free of charge for the defective part returned by you to the dealer.
- c) Warrantor may elect to ship or deliver a replacement part to your address.

## 4. Limitations on Warranty Coverage:

Coverage under this warranty will be valid only if the customer warranty card is returned by the original purchaser within 30 days of purchase.

Coverage under this warranty will be effective only when a copy of the original invoice, showing the date and location of purchase, accompanies any claim for warranty. This warranty is limited to the original owner and is NON TRANSFERABLE to a second party.

Warrantor has no liability whatsoever and this warranty is null and void if any Demco product has been misassembled or subjected to neglect, negligence, misuse, accident or operated in any way contrary to the operating and maintenance instructions as specified in the Demco Owner's Manual for that model.

This warranty does not cover any product that has been altered or modified so as to affect its operation, performance or durability, or that has been modified to change the intended use of the product.

In addition, the warranty does not extend to repairs made necessary by normal use of parts, accessories or other equipment which in the judgment of Warrantor, are either incompatible with the Demco product, or affect its operation, performance or durability.

This warranty does not cover:

- 1) normal wear and tear
- 2) road film or gravel damage to paint
- 3) paint
- 4) rust damage

Warrantor has a policy of continuous product improvement. We reserve the right to change or improve the design of any Demco product, including but not limited to state of the art changes, without assuming any obligation to modify any product previously manufactured.

Warrantor assumes no responsibility to the owner for loss of use of the product, loss of time, inconvenience or other damage consequential or otherwise, including, but not limited to expense for gasoline, expense of transporting the product to the dealer and expense of returning the product, mechanic's travel time, telephone or telegram charges, road service/towing charges, rental of another product during the time warranty repairs are being performed, travel, lodging, loss or damage to personal property or loss of revenue or earnings.

## 5. Limitations of Implied Warranties:

All implied warranties, if any, expire and terminate upon expiration of this warranty. Some states do not allow limitation on how long an implied warranty lasts, so this limitation may not apply to you.

## 6. Limitation of Consequential Damages:

Warrantor's responsibility under this warranty extends solely to repair or replacement of your Demco product and its component parts.

Warrantor does not assume responsibility for, nor shall it be liable for, any special, incidental or consequential damages. Some states do not allow the exclusion or limitation on incidental or consequential damages, so the above exclusion or limitation may not apply to you.

## 7. Purchaser's Rights:

This warranty gives you specific legal rights, and you may also have other rights which vary from state to state.

## 8. Exclusive Warranty:

This is the only express warranty made by Demco on your Demco product and no agent, employee, or other person is allowed to change or add to this warranty.

# NOTES

# NOTES



4010 320th St., P.O. BOX 189, BOYDEN, IA. 51234  
PH: (712) 725-2311 FAX: (712) 725-2380 or 1-800-845-6420  
TOLL FREE: 1-800-54DEMCO (1-800-543-3626)  
[www.demco-products.com](http://www.demco-products.com)